

CROMARTY

7882 / SKU 1378001

astro

GB Products with electronic ballasts / drivers must not be installed on the same electrical circuits as products with inductive loads, for example magnetic fluorescent luminaires, motors or ventilators. Inductive loads can generate excessive voltage surges which can damage electronic ballasts.

FR Les luminaires utilisant un ballast électronique / drivers ne peuvent être installés sur le même circuit que des appareils avec charges inductives, tels que luminaires fluorescents magnétiques, moteurs et ventilateurs. Les charges inductives peuvent générer des voltages excessifs et ainsi endommager les ballasts électroniques.

IT Tutti i prodotti che includono ballast elettronici non devono essere installati sugli stessi circuiti elettrici come anche prodotti con carichi induttivi quali lampadari a fluorescenza magnetica, motori o ventilatori. I carichi induttivi possono generare scariche eccessive che possono danneggiare i ballast.

DE Produkte mit elektronischen Vorschaltgeräten/ Treibern dürfen nicht im selben Stromkreislauf installiert werden wie Verbraucher mit induktiven Lasten, z.B. magnetische Leuchtstofflampen, Motoren oder Ventilatoren. Induktive Lasten können übermäßige Spannungsspitzen erzeugen, die elektronische Vorschaltgeräte beschädigen könnten.

GB
PLEASE READ THE INSTRUCTIONS CAREFULLY
BEFORE COMMENCING ASSEMBLY

Live: Normally Brown / Red
Neutral: Normally Blue / Black
Earth: Normally Green / Yellow

FR
LIRE ATTENTIVEMENT LES INSTRUCTIONS
AVANT DE COMMENCER LE MONTAGE

Phase: Normalement Brun / Rouge
Neutre: Normalement Bleu / Noir
Terre: Normalement Vert / Jaune

IT
LEGGERE ATTENTAMENTE LE ISTRUZIONI
PRIMA DI COMINCIARE L'ASSEMBLAGGIO

Cavo positivo: normalmente marrone o rosso
Cavo neutro: normalmente blu o nero
Cavo terra: normalmente verde o giallo

DE
LESEN SIE BITTE DIE ANWEISUNGEN
SORGFALTIG DURCH, BEVOR SIE MIT DEM
ZUSAMMENBAUEN BEGINNEN

Phase: Normalerweise Braun / Rot
Nulleiter: Normalerweise Blau / Schwarz
Erde: Normalerweise Grün / Gelb



UNSUITABLE FOR DIMMING
Ne convient pour gradateur
Non dimmerabile
Nicht zum Dimmen geeignet

1

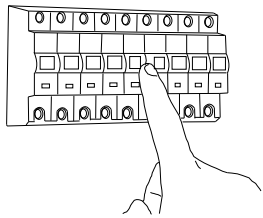

TURN OFF POWER
Couper Le Courant! / Strom Abhalten!
/ Corte La Corriente!

2a

INSTALLATION IN GROUND/LOOSE SURFACE. NOT REQUIRED FOR DECKING

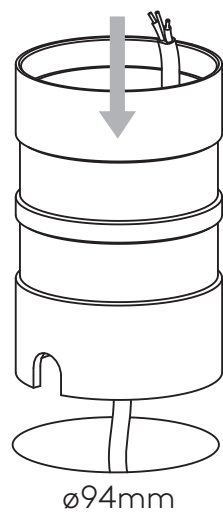

2b

INSTALLATION IN DECKING

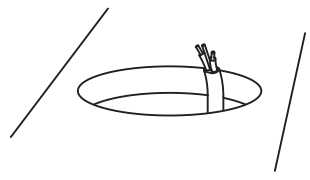
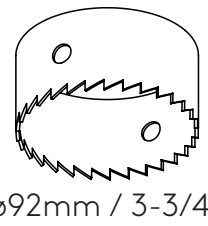

3

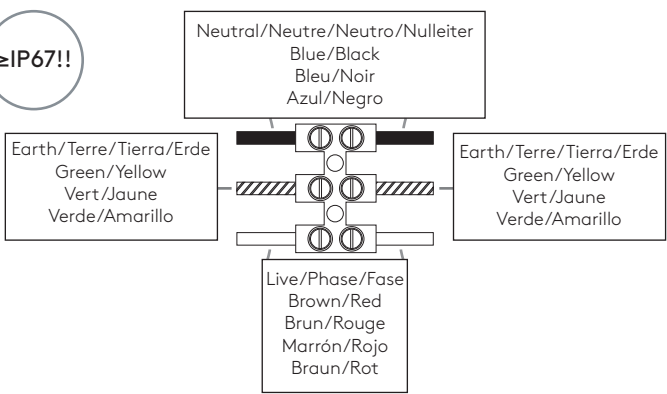
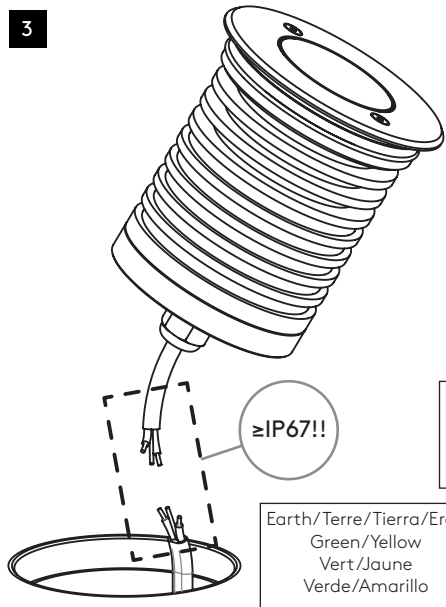

4

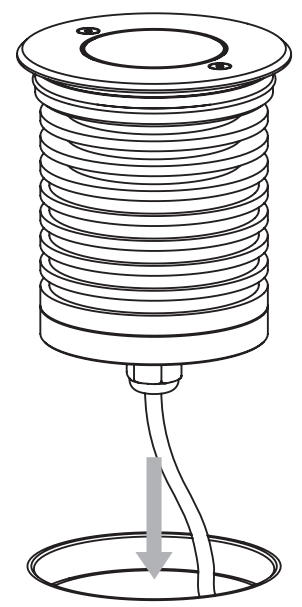

5

