

# BORGOTRIMLESS 98

astro

## GENERAL

LOCATION:	Interior
CLASS:	CE (Class III)
IP RATING:	IP20
BATHROOM ZONE:	Zone 3
VOLTAGE:	Constant Current 700mA
INSTALLATION ORIENTATION:	Wall Mount - Vertical
MAIN MATERIAL:	Metal - Mild Steel
DIMENSIONS:	H: 212mm W: 146mm D: 64mm
CUT OUT HOLE:	L: 164mm W: 98mm
RECESS DEPTH:	64mm
FIRE RATING:	Not Applicable
CABLE LENGTH:	Not Applicable
GROSS WEIGHT:	0.88Kg

## LAMP

LIGHT SOURCE:	HIGH POWER LED
MAXIMUM WATTAGE:	2W
LAMP INCLUDED:	Yes (Integral)
MAXIMUM LAMP LENGTH:	Not Applicable
LUMINOUS FLUX:	84 lm
COLOUR TEMP:	3000K
CRI:	90
R9:	14.6
MACADAM ELLIPSE:	3-Step
TILT ADJUSTABLE ANGLE:	Not Applicable
ROTATION ADJUSTABLE ANGLE:	Not Applicable
AVERAGE LIFESPAN:	60,000hrs
L70:	>60,000hrs
BEAM ANGLE:	Not Applicable

## ELECTRICAL

SWITCHED:	No
DIMMABLE:	Yes
DIMMING METHOD:	Control Gear Dependent
DRIVER INCLUDED:	No
DRIVER OUTPUT CURRENT:	Not Applicable
DRIVER OUTPUT VOLTAGE:	Not Applicable
SUPPLY FREQUENCY:	Not Applicable
DRIVER/BALLAST VOLTAGE:	Not Applicable
DRIVER AVERAGE LIFESPAN:	Not Applicable
EFFICACY:	22.11lm/W

## ADDITIONAL INFORMATION

SHADE INCLUDED:	Not Applicable
SHADE MATERIAL:	Not Applicable
F MARK:	Suitable for mounting on flammable materials
OTHER:	Product tested with 1836 - LED Driver CC 250/350/500/700mA DALI Dim



CODE: 1212041 (7841)  
FINISH: MATT WHITE

TO MAINTAIN THIS PRODUCT TO ITS BEST CONDITION, PLEASE VIEW OUR CARE AND CLEANING GUIDE ON THE SUPPORT SECTION OF THE ASTRO WEBSITE.

Pour entretenir au mieux ce produit, veuillez consulter notre guide d'entretien et de nettoyage, dans la rubrique d'aide sur le site Web d'Astro.

Um dieses Produkt im besten Zustand zu erhalten, beachten Sie bitte unseren Leitfaden zu Pflege und Reinigung im Abschnitt „Support“ auf der Astro-Website.

Per mantenere questo prodotto nelle sue migliori condizioni, consultare la nostra guida per la manutenzione e la pulizia nella sezione dedicata all'assistenza del sito Web Astro.

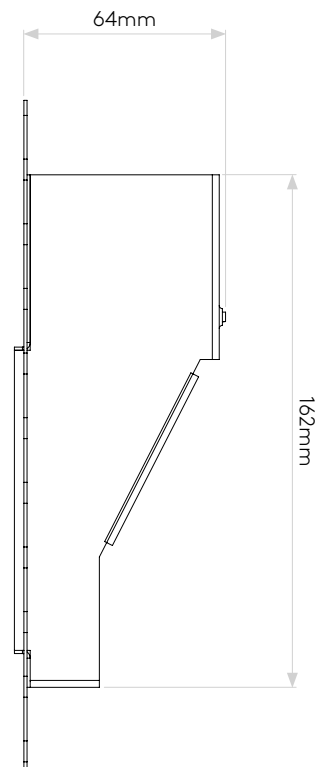
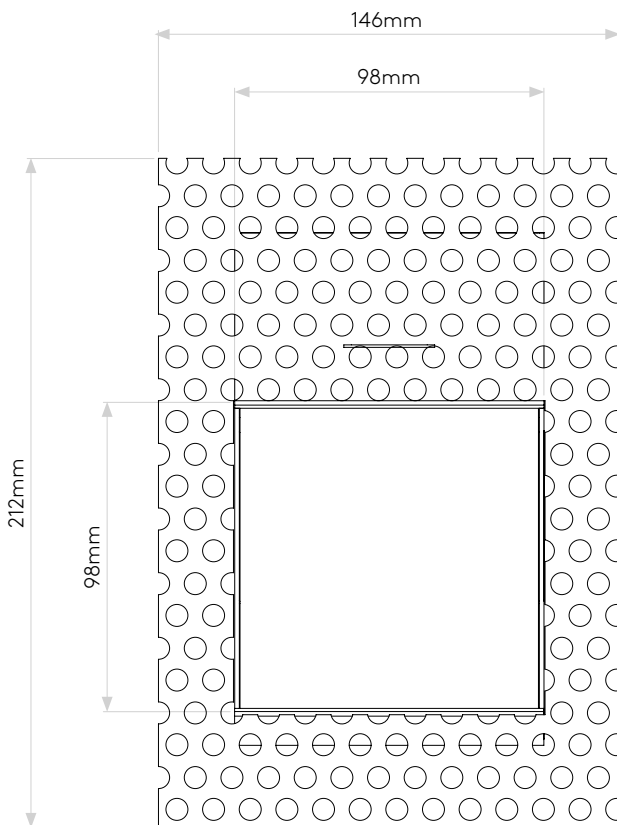
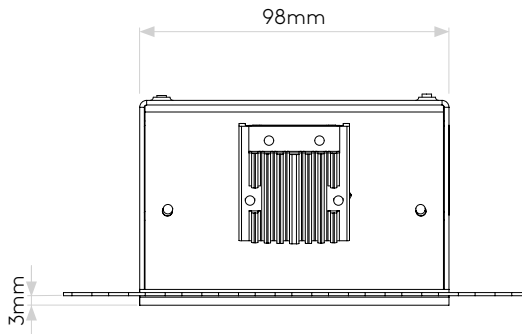

Please note that some dimensions may vary slightly due to manufacturing tolerances, this includes cable entry and fixing holes.

Veillez noter que certaines dimensions peuvent varier légèrement en raison des tolérances de fabrication, y compris l'entrée de câble et les trous de fixation.

Bitte beachten Sie, dass die Maße Fertigungstoleranzen unterliegen und daher in geringem Umfang von der angegebenen Größe abweichen können. Dies gilt auch für Kabeingänge und Befestigungslöcher.

Si prega notare che possono esserci piccole variazioni in alcune dimensioni dovute alle tolleranze di produzione, queste includono l'ingresso del cavo e i fori di fissaggio.