

Pinhole Pro Round Adjustable

astro

Product Overview

Location:	Interior
Class:	CE (Class III)
Ip Rating:	IP20
Bathroom Zone:	Zone 3
Driver Required:	Constant Current 300mA Max
Installation Orientation:	Ceiling Mount Plaster Board Installation Only. Not Suitable For Mounting In A Solid Ceiling. Retrofit
Main Material:	Metal - Mild Steel
Dimensions (mm):	D: 92 Ø: 95
Cut Out Hole (mm/inches):	Ø: 83/3-1/4
Recess Depth (mm):	150
Light Source:	COB LED
Wattage:	10.3W
Tilt Adjustable Angle (°):	25
Dimmable:	Yes (Control Gear Dependent)
Fire Rating:	30 min & 90 min Solid Joist; 30 min Metal Web/I-Joist EN1365-2
F Mark:	Not Suitable For Covering With Thermal Insulation
Gross Weight (kg):	Configuration Dependant

Configuration Options:

Beam:	Narrow/Medium/Wide
Colour Temp (K):	2700/3000
CRI (typ):	Edge 90+/Essence 95+ (98typ.)
Dimming Method:	DALI/Phase
Installed filter:	Linear/Honeycomb/Diffuser

* Photometric information will vary depending on the specific configuration.
Please see website for more details



Finish: Matt White

To maintain this product to its best condition, please view our care and cleaning guide on the support section of the astro website.

Pour entretenir au mieux ce produit, veuillez consulter notre guide d'entretien et de nettoyage, dans la rubrique d'aide sur le site Web d'Astro.

Um dieses Produkt im besten Zustand zu erhalten, beachten Sie bitte unseren Leitfaden zu Pflege und Reinigung im Abschnitt „Support“ auf der Astro-Website.

Per mantenere questo prodotto nelle sue migliori condizioni, consultare la nostra guida per la manutenzione e la pulizia nella sezione dedicata all'assistenza del sito Web Astro.

	Edge (High Efficacy)						Essence (High Quality)		
	2700K			3000K			2700K		
	Narrow	Medium	Wide	Narrow	Medium	Wide	Narrow	Medium	Wide
Beam									
Beam Angle	21	31	46	22	31	46	22	31	46
Light Source Lumens (lm)	1834			1872			1127		
Light Source Rating (W)	10.3			10.3			10.2		
Light Source lm/W	178			182			110		
Luminaire Lumens (lm)	959.3	996.1	999.9	1029	1134	1181	680	764	779
Luminaire Rating (W)	11.7			11.8			11.8		
Luminaire lm/W	81	85	85	86	96	100	57	65	67
Luminaire Intensity (Cd)	5952	3905	2014	6275	4405	2326	4304	3041	1596
Forward Voltage (Vf)	34.5			34.5			34		
Max. Drive Current (mA)	300			300			300		
Total Circuit Watts (typ.)	11.7			11.8			11.8		
Binning	2-Step SDCM			2-Step SDCM			2-Step SDCM		
CRI (typ.)	90+			90+			95+ (98typ.)		
TM30-15 (Rf/Rg)	93.2/100.9			93.1/100.2			97/102		
Lightsource Lifetime (hrs)	L90B10 150,000 (calculated)			L90B10 150,000 (calculated)			L90B10 125,000 (calculated)		
Lifetime inc. Driver (hrs)	L90 B10 50,000hrs+*			L90 B10 50,000hrs+*			L90 B10 50,000hrs+*		
Dimming Options	DALI/Phase			DALI/Phase			DALI/Phase		
Dimming Range	1-100%/5-100%/1-100%			1-100%/5-100%/1-100%			1-100%/5-100%/1-100%		
Max Distance Driver LED (M)	2			2			2		
Emergency	Emergency pack available as accessory			Emergency pack available as accessory			Emergency pack available as accessory		

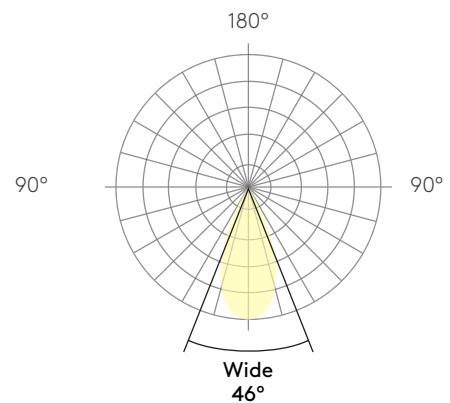
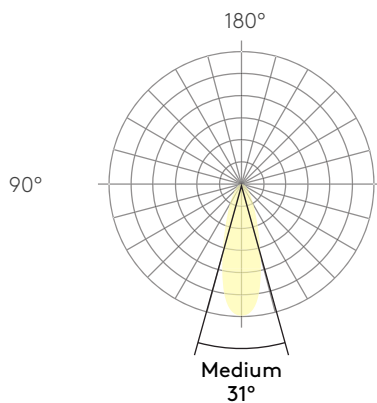
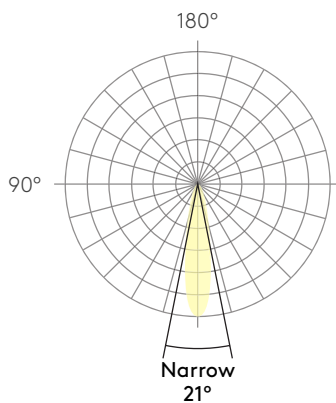

*at 60°C running temp.

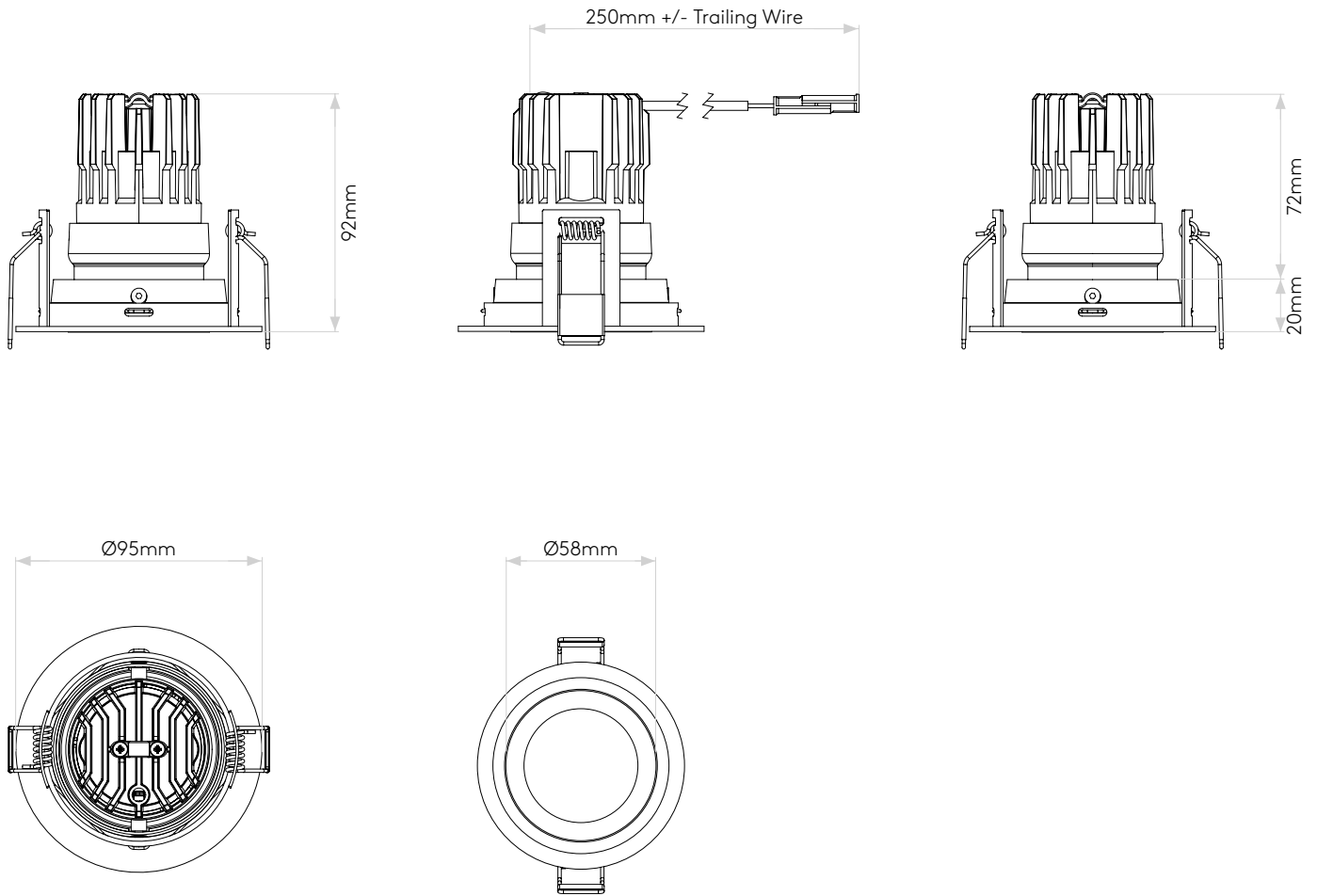

Please note that some dimensions may vary slightly due to manufacturing tolerances, this includes cable entry and fixing holes

Veuillez noter que certaines dimensions peuvent varier légèrement en raison des tolérances de fabrication, y compris l'entrée de câble et les trous de fixation.

Bitte beachten Sie, dass die Maße Fertigungstoleranzen unterliegen und daher in geringem Umfang von der angegebenen Größe abweichen können. Dies gilt auch für Kabeingänge und Befestigungslöcher.

Si prega notare che possono esserci piccole variazioni in alcune dimensioni dovute alle tolleranze di produzione, queste includono l'ingresso del cavo e i fori di fissaggio.